

website: www.multiskillengineers.com

MULTI SKILL ENGINEERS

Specialist in manufacturing of hydraulic cylinders

Manufactures, Repair & Services of -

- Hydraulic cylinders
- Hydraulic power pack
- Hydraulic jack
- Manifold (oil block)

For enquiry:

Email- contact@multiskillengineers.com

Placement of orders:

Email- sales@multiskillengineers.com



Registered Address - plot no. 09, sy no. 347 ,opp TATA motors, Udyambag, Belgavi – 590006
Contact- +91 98446 08536 , +91 96323 70918

ABOUT COMPANY

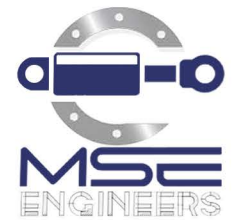

The company was started its journey in the year 2007. MULTISKILL ENGINEERS has been in the business of Hydraulic Cylinder since more than one and half decades. We have built a reputation for excellence and cost effective cylinder manufacturing / reconditioning. Also we provide service provider for manufacturing / reconditioning of cylinders in India. Multi-skill engineers has facilities for manufacturing / reconditioning of all types of pneumatic and hydraulic cylinders as well as a variety of other hydraulics related components.

Multiskill engineers is built with the team of professionals, who understands customer need and are committed to full fill their requirements within the stipulated time keeping in mind of the cost. We have focused ourselves mainly in the field of hydraulic cylinders, Power Pack Units, Hand Pumps, lifting platform, Customized and std. Cylinders, Hydraulic Valves, custom built systems, & various special tools & equipment. Even reconditioning of all Indian and overseas based hydraulic machines.

Our products are most suited and widely used in Manufacturing industries, Sugar Industries, Cement Industries Mining, Shipping, Construction companies, Automobile Industries, Rail-way Dept, textile Industries, forging industries, and so many other manufacturing premises.

We would be pleased to be the technically competent and reliable business partner by your side, dedicated to quality and committed to service with integrity. If your company, have been thinking of buying and refurbishing Hydraulic Jacks, Cylinders or any related equipment's, we would like to meet with you to discuss your future objectives and how our services may be of help in obtaining your overall goals.

DIRECTOR
Pratik khupre

MULTI SKILL ENGINEERS

specialist in manufacturing of hydraulic cylinder
Address-plot no. 09, sy no. 347 ,opp TATA motors, Udyambag, Belgavi – 590006

OUR MISSION

- We manufacture and repair Hydraulic cylinders and power packs etc. Our customers expect hydraulic solutions including automation.
- We offer optimum designs and use highly skilled and experienced workmen and appropriate equipments.
- We offer a variety of products and jobs in the hydraulic domain and handle large no of customers

QUALITY CONTROL

- We believe all people who are working for **MULTI SKILL ENGINEERS** are quality conscious ! Giving right and Quality control product is a must.
- All team members know their purpose and objectives and we keep on pushing the bar upwards.
- We are proud of what we do. This helps us to give right quality and design.
- We have mix blend of conventional as well as modern machineries like CNC and VMC .

OUR VISION

- our vision is to build a quality brand and complete satisfaction to the clients as per their requirements.
- We believe to update and upgrade our machineries and our team from time to time so as to cater increasing no of customers and their demand.
- We shall offer the best in class products and services for our customers. We will increase the effectiveness of our business through processes like Lean Manufacturing, Continuous Improvement, Teamwork and by involving employees and other stakeholders in decision making.

MULTI SKILL ENGINEERS

specialist in manufacturing of hydraulic cylinder
Address-plot no. 09, sy no. 347 ,opp TATA motors, Udyambag, Belgavi – 590006

Index

01) Introduction

02) About company

03) Mission & Vision

04) Index

05) Our products

06) Hydraulic cylinder
(Single acting)

07) Hydraulic cylinder
(Double acting)

08) Hydraulic cylinder
types

09) Hydraulic cylinder
types

10) Power pack

11) Hydraulic jack

12) Manifold
(Oil block)

13) Gallery

14) Why US

Our products

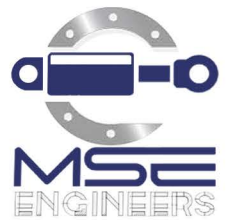

RANGE OF HYDRAULIC EQUIPMENTS:

1. High/Low Pressure Hydraulic Cylinders (Single acting)
2. High/Low Pressure Hydraulic Cylinders (Double acting)
3. High/Low Pressure Hydraulic Power Pack Units
4. High/Low Pressure Hydraulic Jacks
5. Manifold (Oil blocks)

MULTI SKILL ENGINEERS was established in the year 2007 and today we are the manufacturers of the wide spectrum Hydraulic cylinders, hydraulic power pack , hyadralic jacks .We are manufacturing these products using premium grade raw material that is procured from the authentic vendors of the market. We deliver these products within the promised time-frame.

MULTI SKILL ENGINEERS

specialist in manufacturing of hydraulic cylinder

Address-plot no. 09, sy no. 347 ,opp TATA motors, Udyambag, Belgavi – 590006

Hydraulic cylinder

(Double acting)

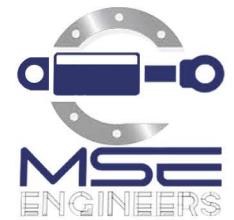

APPLICATION:

These Cylinders are designed to provide oil force in both the advance and retraction of ram, in vertical & horizontal position, where cycle time is crucial. These are mainly used for hydraulic testing machine and for lifting, lowering, spreading of structures, bridges, heavy machinery, etc.

FEATURES & ADVANTAGES:

- Alloy steel body for better life.
- Hard chrome-plated ram to resist scoring & corrosion.
- Ideal for heavy duty application.
- Provides force in advance & return cycles.
- High pressure long life seals. Ram wiper protects inner cylinder from dirt which extends cylinder life.
- Relief valve protects against over pressurizing.
- Bottom mounting holes, collar threading are provided on request.
- Connection Port size 3/8 inch NPT.
- Available in custom strokes also.

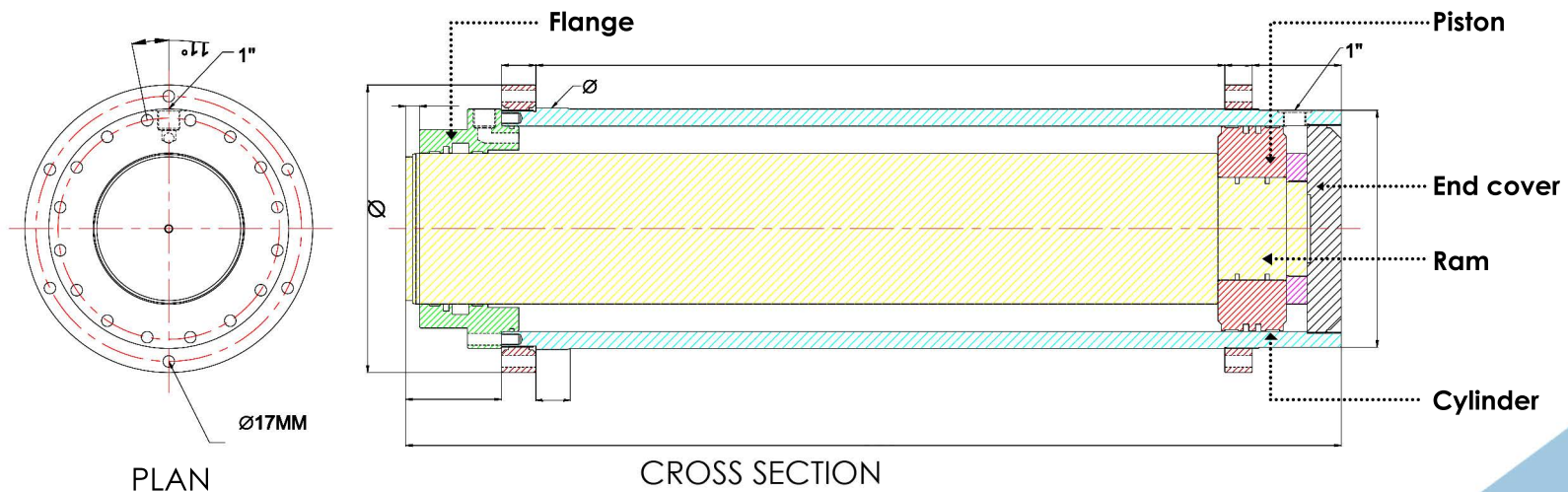

MULTI SKILL ENGINEERS

specialist in manufacturing of hydraulic cylinder
Address-plot no. 09, sy no. 347 ,opp TATA motors, Udyambag, Belgavi – 590006

Hydraulic cylinder

TYPES

HYDRAULIC MANUFACTURING:

We MULTI SKILL ENGINEERS team believe , to first understand the customer's needs then to know the working application then the usage , working stroke, acting load , working environment , repeatability of working i.e no of working cycles , by which we can help to choose the right type of cylinders that can be used , like mounting type , operating pressure , types of seals to incorporate to give max life of the cylinders , material selection in making the hydraulic cylinders.

Partnering with early in the design phase saves engineering teams time and money while ensuring the final system does its assigned



Fork type cylinders



Front or rear flange type cylinders



Both end pin EYE cylinders



Both end Clevis with spherical bearings cylinders



Trunnion type cylinders



Both ends rods cylinders



Swing type cylinders



Clamping type cylinders



Long strokes cylinders



Double ended type for sensor positioning cylinders



Swivel type cylinders



Small bore cylinders

MULTI SKILL ENGINEERS

specialist in manufacturing of hydraulic cylinder

Address-plot no. 09, sy no. 347 ,opp TATA motors, Udyambag, Belgavi – 590006

Hydraulic cylinder

TYPES

We can design and manufacture for OEMs / single machine manufacturer / in-house machine building for particular applications / vehicle mounted / due to which we have variety in manufacturing any type of cylinders some are the following list of cylinder types that we manufacture In tie rod as well as welded type and some special type

Our customer expects hydraulic solutions from us , so we have designed various models with stress analysis of cylinders over the machinery in our latest CAD-CAM software for demonstrations.



Press Cylinders



Bottle type cylinders



Pencil type cylinders



Very High pressure type cylinders



Large bore type cylinders



Hinged type cylinders



Bottom mounting cylinders



Side mounting cylinders



Hydraulic Cylinders



Mill Type cylinders



Heavy duty bolted types cylinders



Full Threaded type cylinders

MULTI SKILL ENGINEERS

specialist in manufacturing of hydraulic cylinder

Address-plot no. 09, sy no. 347 ,opp TATA motors, Udyambag, Belgavi – 590006

Power pack

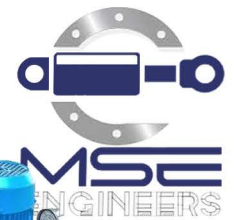

DESCRIPTION:

A hydraulic power pack is a self-contained unit that consists mainly of a motor, a tank / reservoir hydraulic pump, valves, gauges. Using fluid to transmit power from one location to another, hydraulic power packs can generate massive amounts of flow and pressurised oil to drive hydraulic machinery like

SPECIFICATIONS:

With knowing the application we can design and manufacture
Upto 250-300 tons capacity
All types of valve available
Tank size upto 1000 Ltrs
Light duty and Medium duty Power packs
Hand Operated as well as by control panel operated valves
Pumps companies that we use : WEG- 3 Yrs warranty/ Yuken / Polyhydron /simens/Bharat bijli etc

Valves companies that we use : yuken / Polyhydron / poly flow /prism hydraulics
Motors companies that we use : Siemens / Crompton
Voltage : AC / DC / Battery operated

APPLICATIONS :

Steel Process and Manufacturing
Paper Process and Manufacturing
Plastics Process and Manufacturing machines
Manufacturing of Press machine
Manufacturing of UTM Machine



Hydraulic jacks

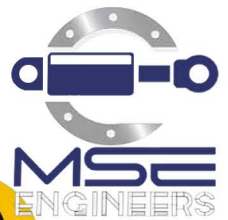

APPLICATION:

These jacks are an excellent choice for maintenance, positioning bending, pressing, and production application. Ideal for a wide range of applications at construction sites, automobile, shipyard, mills, railway workshops, power plants and Industrial maintenance.

SINGLE AND DOUBLE ACTING JACKS:

Our hydraulic jacks and jacking equipment is designed by practical experience within the civil and construction industry, mainly used for heavy lifting, pre-loading, pre-stressing or lowering applications. We provide a wide range of hydraulic jacking systems, from hand-operated or electric pumps with control manifolds and pressure gauges, as illustrated below, to state of the art computerised control and monitoring equipment used for precise controlled hydraulic movement when carrying out major lifting projects, such as, bridge or house lifting operations or other large heavy structures.

Our range of low height hydraulic jacks vary from 5 to 520 tons capacity and are designed to work in the toughest environments to which this type of equipment is normally associated. Our hydraulic jacks are also equipped with locking collars to mechanically lock-off the ram after lifting and swivel heads to ensure that the load is transferred centrally through the jack.



MULTI SKILL ENGINEERS

specialist in manufacturing of hydraulic cylinder
Address-plot no. 09, sy no. 347, opp TATA motors, Udyambag, Belgavi – 590006

Manifold (oil block)

DESCRIPTION:

A hydraulic manifold is a component that regulates fluid flow between pumps and actuators and other components in a hydraulic system. It could be compared to a switchboard in an electrical circuit, because it lets the operator control how much fluid flows between components of a hydraulic machinery. For example, in a backhoe loader, a manifold turns on or shuts off or diverts flow to the telescopic arms of the front bucket and the back bucket. The manifold is connected to the levers in the operator's cabin, which the operator uses to achieve the desired behavior.

A manifold is composed of assorted hydraulic valves connected to each other. It is the various combinations of states of these valves that allow complex control behavior in a manifold.



APPLICATIONS :

- Manufacturing of Press machine
- Steel Process and Manufacturing
- Paper Process and Manufacturing
- Plastics Process and Manufacturing machines
- Manufacturing of UTM Machine



Gallery

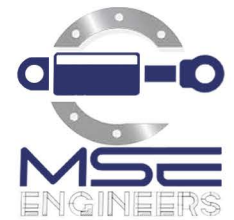

MULTI SKILL ENGINEERS

specialist in manufacturing of hydraulic cylinder
Address-plot no. 09, sy no. 347 ,opp TATA motors, Udyambag, Belgavi – 590006

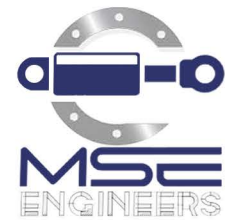

Why Customer Always Choose

Why us..?



High-end Design & Engineering capabilities Backed by latest software and techniques

Backed by latest software and techniques



Flexible Manufacturing process

Driven by sophisticated machinery, tools



Customer Satisfaction

98% customer retention



Testing capabilities / Simulation

Top-end Test bench and Impulse Test Rig ensuring high-reliability products, on-time



National Presence

We have been providing sales and services in maharashtra, goa and



World class Quality

International Quality standards and stringent in-house QA and QC leading to our "Zero Defect" product



Responsive Post-sales support

SLA based timely resolution, Skilled professionals, Back-up spares



Just-in-time Delivery

Our OEM customers' production lines are always fed with the right Hydraulic products at the right time

MULTI SKILL ENGINEERS

specialist in manufacturing of hydraulic cylinder

Address-plot no. 09, sy no. 347 ,opp TATA motors, Udyambag, Belgavi – 590006